

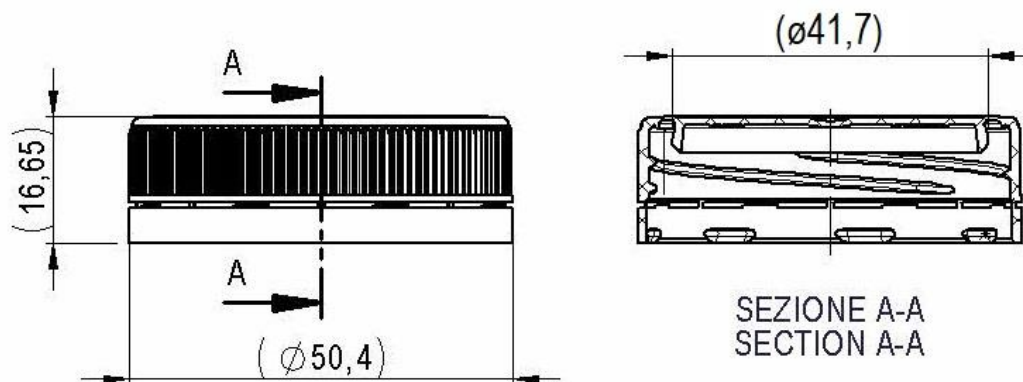







Art. cod. 00118

Descrizione / Description / Description
Capsula $\varnothing 48$ 3P T.E.
 $\varnothing 48$ cap 3P T.E.
Capsule $\varnothing 48$ 3P T.E.

Tabella dati tecnici / Technical data table / Tableau données techniques

					
Tipo filetto	Passo filetto (mm)	N° Principi filetto	Sigillo di garanzia	Materiale	Peso (g)
Thread type	Thread pitch (mm)	N° Thread starts	Tamper evident	Material	Weight (g)
Type filet	Pass de filet (mm)	N° Pass de vis filet	Inviolabilité	Matière	Poids (g)
-	10,17	3	Si/Yes/Oui		4,50 \pm 0,15

Il peso indicato è puramente indicativo e non valido ai fini CONAI.

The weight indicated is purely indicative.

Le poids indiqué est indicatif.

Tabella dati imballaggio-spedizione / Table packing and shipping details / Table données d'emballage-expédition

Scatola standard (cm)	Sacchetto	Quantità per scatola	Quantità per pallet	Pallet (cm)
<i>Standard box (cm)</i>	<i>Bag</i>	<i>Pcs box</i>	<i>Pcs pallet</i>	<i>Pallet (cm)</i>
<i>Carton standard (cm)</i>	<i>Sachet</i>	<i>Pcs carton</i>	<i>Pcs palette</i>	<i>Palette (cm)</i>
80x40 H:32	PE Food contact	2000	36000	120x80 H:203,5



Stoccaggio / Storage / Stockage

Conservare i prodotti nella loro confezione originale in un luogo pulito, fresco e asciutto.

Store the products in their original packaging in a clean, cool and dry place.

Stocker les produits dans leur emballage d'origine dans un endroit propre, frais et sec.

Temperatura / Temperature / Temperature : **5÷30°C**

Umidità / Humidity / Humidité : **45÷75%**

Conservare i prodotti a temperatura ambiente (**20°C±5**) per **48 ore** prima dell'uso sulla macchina confezionatrice.

Store the products at room temperature (20°C±5) for 48H before using on packaging machine.

Stocker les produits à température ambiante (20°C±5) pendant 48 heures avant l'utilisation sur la machine d'emballage.