

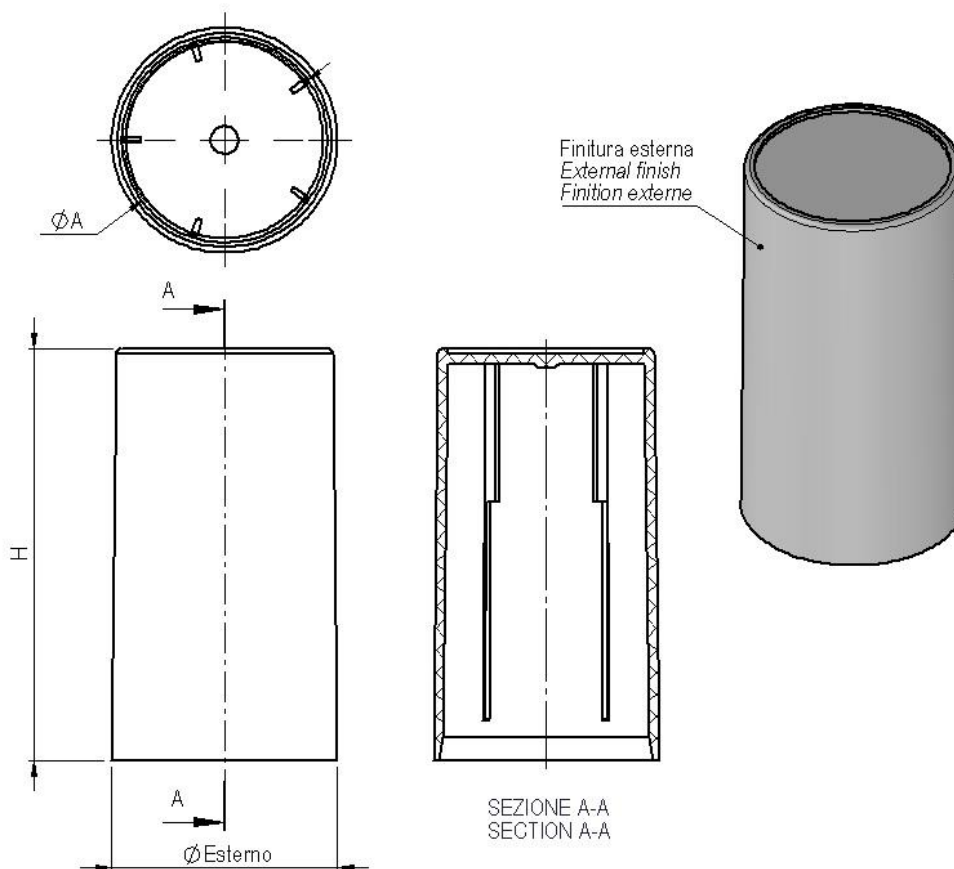





Art. cod. 00169

Descrizione / Description / Description

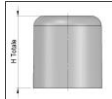
Cappuccio con nervature $\varnothing e23$ H=42Cap with ribs $\varnothing e23$ H=42Capsule avec des côtes $\varnothing e23$ H=42
Tabella dati tecnici / Technical data table / Tableau données techniques

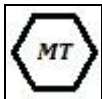
|  |  |  |  |  |  |
|---|---|---|---|---|---|
| \varnothing Esterno (mm) | Altezza H (mm) | \varnothing Aggancio A (mm) | Finitura esterna | Materiale | Peso (g) |
| External \varnothing (mm) | Height H (mm) | \varnothing Engagement A (mm) | External finish | Material | Weight (g) |
| \varnothing Extérieur (mm) | Hauteur H (mm) | \varnothing D'engagement A (mm) | Finition externe | Matière | Poids (g) |
| 23 | 42 | 20,5 | Lucido/Glossy/ Brillant |  | 2,90 \pm 0,25 |

Il peso indicato è puramente indicativo e non valido ai fini CONAI.

The weight indicated is purely indicative.

Le poids indiqué est indicatif.

Tabella dati imballaggio-spedizione / Table packing and shipping details / Table données d'emballage-expédition

| Scatola standard (cm) | Sacchetto | Quantità per scatola | Quantità per pallet | Pallet (cm) |
|-----------------------------|--------------------|----------------------|---------------------|---------------------|
| <i>Standard box (cm)</i> | <i>Bag</i> | <i>Pcs box</i> | <i>Pcs pallet</i> | <i>Pallet (cm)</i> |
| <i>Carton standard (cm)</i> | <i>Sachet</i> | <i>Pcs carton</i> | <i>Pcs palette</i> | <i>Palette (cm)</i> |
| 60x40 H:33,5 | PE Food contact | 2800 | 33600 | 120x80 H:112 |

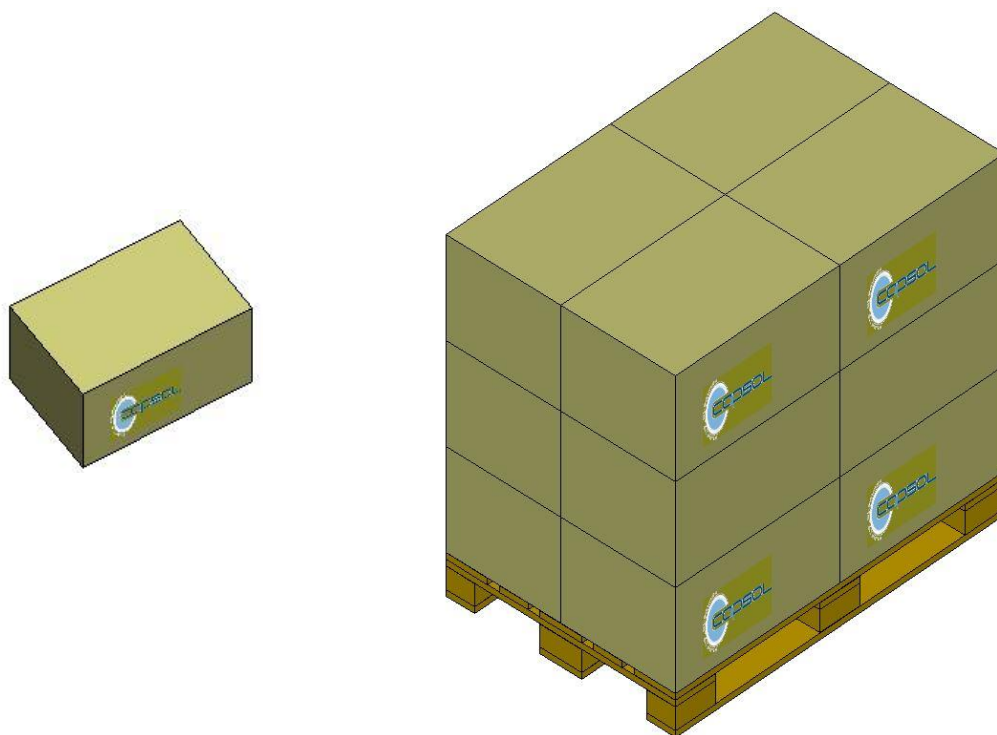

Stoccaggio / Storage / Stockage

Conservare i prodotti nella loro confezione originale in un luogo pulito, fresco e asciutto.
Store the products in their original packaging in a clean, cool and dry place.
Stocker les produits dans leur emballage d'origine dans un endroit propre, frais et sec.

Temperatura / Temperature / Temperature : **5÷30°C**

Umidità / Humidity / Umidité : **45÷75%**

Conservare i prodotti a temperatura ambiente (**20°C±5**) per **48 ore** prima dell'uso sulla macchina confezionatrice.
Store the products at room temperature (20°C±5) for 48H before using on packaging machine.
Stocker les produits à température ambiante (20°C±5) pendant 48 heures avant l'utilisation sur la machine d'emballage.