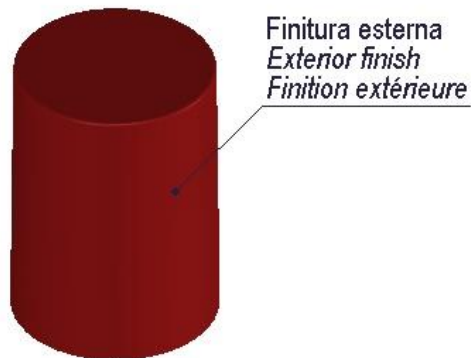
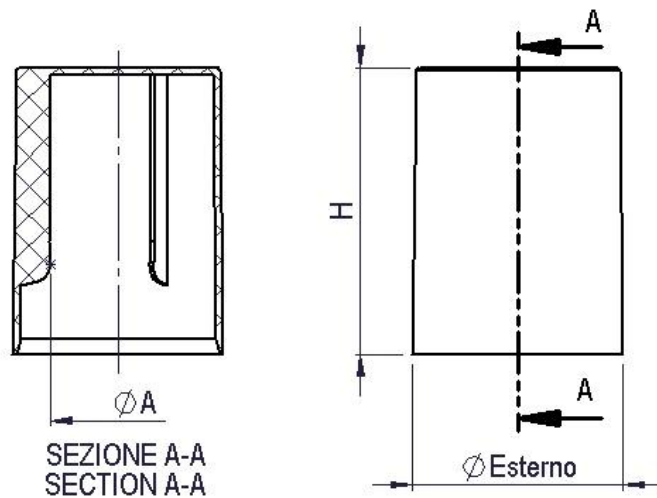
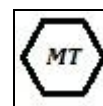
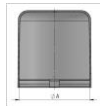
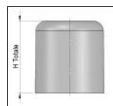
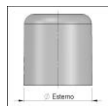

Art. cod. 00173
Descrizione / Description / Description
Cappuccio liscio per valvola $\varnothing 21,2$
Polished cap, for $\varnothing 21,2$ valve
capsule polie, pour valve $\varnothing 21,2$

Tabella dati tecnici / Technical data table / Tableau données techniques

\varnothing Esterno (mm)	Altezza H (mm)	\varnothing Aggancio A (mm)	Finitura esterna	Materiale	Peso (g)
<i>External \varnothing (mm)</i>	<i>Height H (mm)</i>	<i>\varnothing Engagement A (mm)</i>	<i>External finish</i>	<i>Material</i>	<i>Weight (g)</i>
\varnothing Extérieur (mm)	Hauteur H (mm)	\varnothing D'engagement A (mm)	Finition externe	Matière	Poids (g)
31,8	43,5	20,45	Lucida/Glossy/ Brillante		4,90 \pm 0,15

Il peso indicato è puramente indicativo e non valido ai fini CONAI.

The weight indicated is purely indicative.

Le poids indiqué est indicatif.

Tabella dati imballaggio-spedizione / Table packing and shipping details / Table données d'emballage-expédition

Scatola standard (cm)	Sacchetto	Quantità per scatola	Quantità per pallet	Pallet (cm)
<i>Standard box (cm)</i>	<i>Bag</i>	<i>Pcs box</i>	<i>Pcs pallet</i>	<i>Pallet (cm)</i>
<i>Carton standard (cm)</i>	<i>Sachet</i>	<i>Pcs carton</i>	<i>Pcs palette</i>	<i>Palette (cm)</i>
60x40 H:33,5	PE Food contact	1250	15000	120x80 H:112

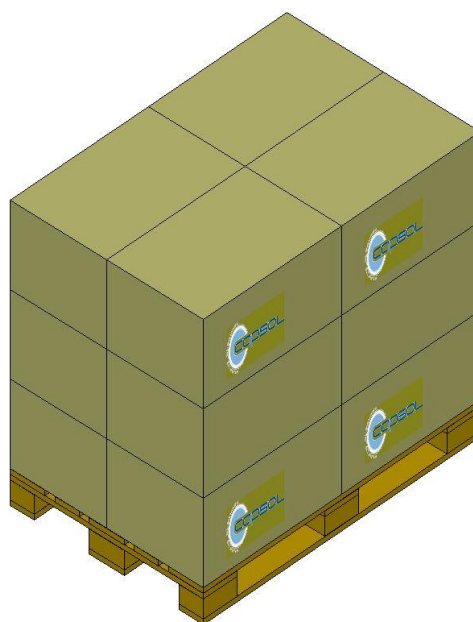

Stoccaggio / Storage / Stockage

Conservare i prodotti nella loro confezione originale in un luogo pulito, fresco e asciutto.
Store the products in their original packaging in a clean, cool and dry place.
Stocker les produits dans leur emballage d'origine dans un endroit propre, frais et sec.

Temperatura / Temperature / Temperature : **5÷30°C**

Umidità / Humidity / Humidité : **45÷75%**

Conservare i prodotti a temperatura ambiente (**20°C±5**) per **48 ore** prima dell'uso sulla macchina confezionatrice.
Store the products at room temperature (20°C±5) for 48H before using on packaging machine.
Stocker les produits à température ambiante (20°C±5) pendant 48 heures avant l'utilisation sur la machine d'emballage.