

Art. cod. 01054.06







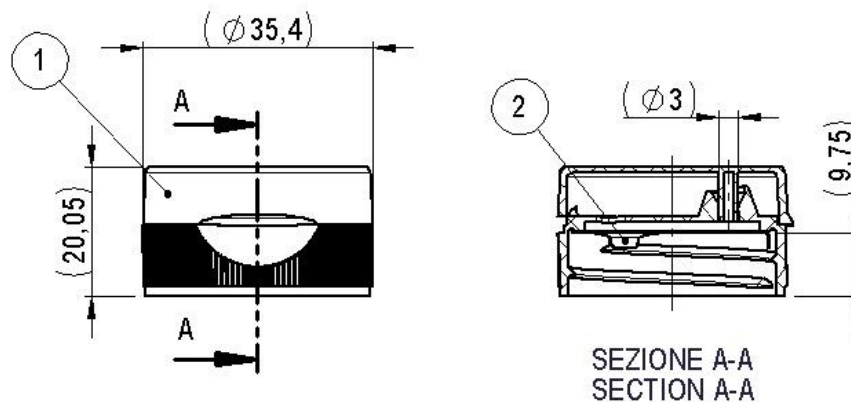
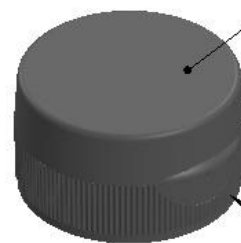

Descrizione / Description / Description
Capsula Flip_Top 33/400 EØ3 Liner Induzione PE-PP
33/400 Flip Top Cap EØ3 with induction liner PE-PP
Capsule Flip Top 33/400 EØ3 avec liner d'induction PE-PP

 Finitura esterna lucida
 Glossy exterior finish
 Finition extérieure brillante

 Finitura esterna 1000 righe
 1000 lines external finish
 Finition externe striée

Tabella dati tecnici / Technical data table / Tableau données techniques

1						
Pos. componente	Tipo filetto	Passo filetto (mm)	N° Principi filetto	Sigillo di garanzia	Materiale	Peso (g)
Component pos.	Thread type	Thread pitch (mm)	N° Thread starts	Tamper evident	Material	Weight (g)
Pos. Du Composant	Type filet	Pass de filet (mm)	N° Pass de vis filet	Inviolabilité	Matière	Poids (g)
1	33/400	-	-	No/No/Non		4,5 ±0,30
2	-	-	-	-		

Il peso indicato è puramente indicativo e non valido ai fini CONAI.

The weight indicated is purely indicative.

Le poids indiqué est indicatif.

Tabella dati imballaggio-spedizione / Table packing and shipping details / Table données d'emballage-expédition

Scatola standard (cm)	Sacchetto	Quantità per scatola	Quantità per pallet	Pallet (cm)
<i>Standard box (cm)</i>	<i>Bag</i>	<i>Pcs box</i>	<i>Pcs pallet</i>	<i>Pallet (cm)</i>
<i>Carton standard (cm)</i>	<i>Sachet</i>	<i>Pcs carton</i>	<i>Pcs palette</i>	<i>Palette (cm)</i>
38x38 H:33	PE Food contact	1700	30600	120x80 H:110,5

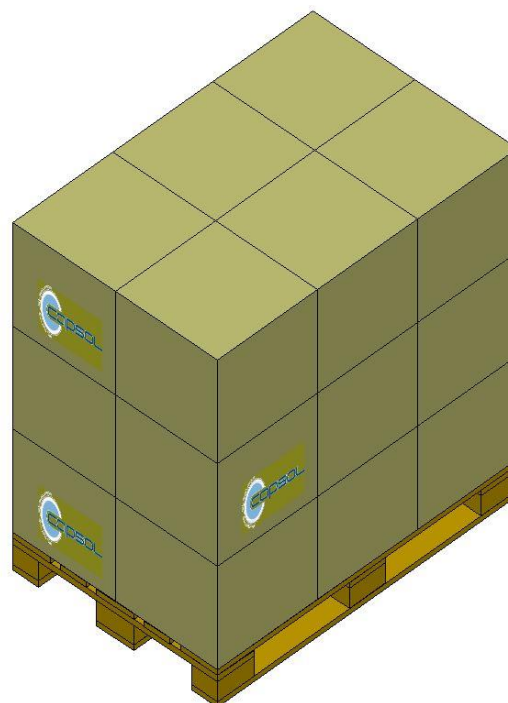
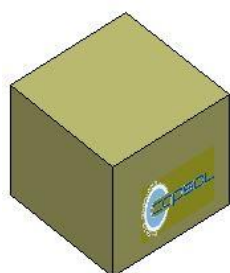

Stoccaggio / Storage / Stockage

Conservare i prodotti nella loro confezione originale in un luogo pulito, fresco e asciutto.

Store the products in their original packaging in a clean, cool and dry place.

Stocker les produits dans leur emballage d'origine dans un endroit propre, frais et sec.

Temperatura / Temperature / Temperature : **5÷30°C**

Umidità / Humidity / Humidité : **45÷75%**

Conservare i prodotti a temperatura ambiente (**20°C±5**) per **48 ore** prima dell'uso sulla macchina confezionatrice.

Store the products at room temperature (20°C±5) for 48H before using on packaging machine.

Stocker les produits à température ambiante (20°C±5) pendant 48 heures avant l'utilisation sur la machine d'emballage.