

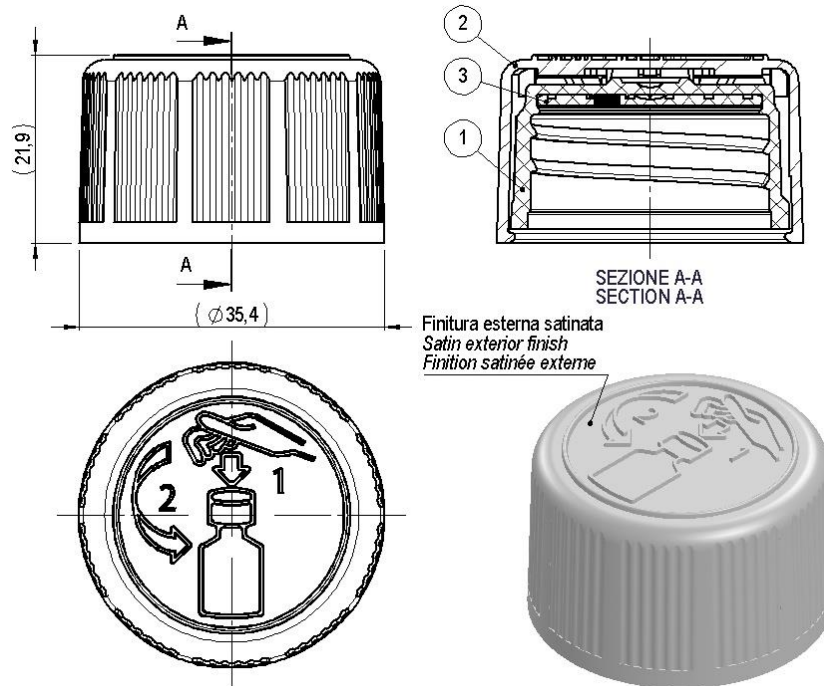



Art. cod. 01094.06

Descrizione / Description / Description
Capsula PFP28 P3 Child Proof guarnizione con sfiato
Child-proof PFP28 P3 cap gasket with vent
Capsule PFP28 P3 sécurité enfant, joint avec évent

Tabella dati tecnici / Technical data table / Tableau données techniques

Pos. componente Component pos. Pos. Du Composant	Tipo filetto Thread type Type filet	Passo filetto (mm) Thread pitch (mm) Pass de filet (mm)	N° Principi filetto N° Thread starts N° Pass de vis filet	Sigillo di garanzia Tamper evident Inviolabilité	Materiale Material Matière	Peso (g) Weight (g) Poids (g)
1	PFP28	3,1	1	No/No/Non		6,70 ±0,25
2	-	-	-	-		
3	-	-	-	-		

Il peso indicato è puramente indicativo e non valido ai fini CONAI.

The weight indicated is purely indicative.

Le poids indiqué est indicatif.

Tabella dati imballaggio-spedizione / Table packing and shipping details / Table données d'emballage-expédition

Scatola standard (cm)	Sacchetto	Quantità per scatola	Quantità per pallet	Pallet (cm)
<i>Standard box (cm)</i>	<i>Bag</i>	<i>Pcs box</i>	<i>Pcs pallet</i>	<i>Pallet (cm)</i>
<i>Carton standard (cm)</i>	<i>Sachet</i>	<i>Pcs carton</i>	<i>Pcs palette</i>	<i>Palette (cm)</i>
38x38 H:33	PE Food contact	1350	24300	120x80 H:110,5



Stoccaggio / Storage / Stockage

Conservare i prodotti nella loro confezione originale in un luogo pulito, fresco e asciutto.

Store the products in their original packaging in a clean, cool and dry place.

Stocker les produits dans leur emballage d'origine dans un endroit propre, frais et sec.

Temperatura / Temperature / Temperature : **5÷30°C**

Umidità / Humidity / Umidité : **45÷75%**

Conservare i prodotti a temperatura ambiente (**20°C±5**) per **48 ore** prima dell'uso sulla macchina confezionatrice.

Store the products at room temperature (20°C±5) for 48H before using on packaging machine.

Stocker les produits à température ambiante (20°C±5) pendant 48 heures avant l'utilisation sur la machine d'emballage.