

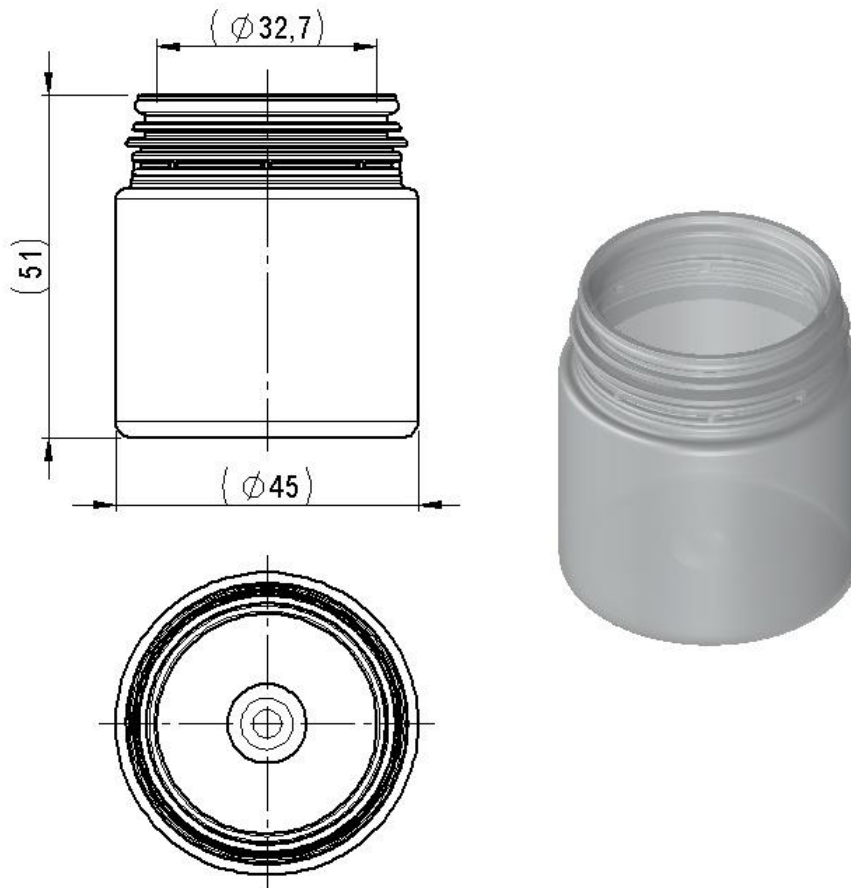

Art. cod. 01F183

Descrizione / Description / Description
Pilloliera 50ml collo pressione TE 01100
50ml pill container, pressure neck TE 01100
Pilulier 50 ml, col à pression TE 01100

Tabella dati tecnici / Technical data table / Tableau données techniques

Tipo filetto	Passo filetto (mm)	N° Principi filetto	Capacità raso bocca (ml)	Materiale	Peso (g)
Thread type	Thread pitch (mm)	N° Thread starts	Brimfull capacity (ml)	Material	Weight (g)
Type filet	Pass de filet (mm)	N° Pass de vis filet	Contenance ras-bord (ml)	Matière	Poids (g)
-	-	-	63,0 ±4,0		14,0 ±1,0

Il peso indicato è puramente indicativo e non valido ai fini CONAI.

The weight indicated is purely indicative.

Le poids indiqué est indicatif.



PLASTIC CLOSURES

.....▶ www.capsol-spa.com

Tabella dati imballaggio-spedizione / Table packing and shipping details / Table données d'emballage-expédition

Termopacco (cm)	Quantità per termopacco	Quantità per pallet	Pallet (cm)
<i>Packaging with thermopack (cm)</i>	<i>Quantity per thermopack</i>	<i>Pcs pallet</i>	<i>Pallet (cm)</i>
<i>Emballage avec thermopack (cm)</i>	<i>Quantité par thermopack</i>	<i>Pcs palette</i>	<i>Palette (cm)</i>
120x80 H:	800	6400	120x80 H:

Stoccaggio / Storage / Stockage

Conservare i prodotti nella loro confezione originale in un luogo pulito, fresco e asciutto.

Store the products in their original packaging in a clean, cool and dry place.

Stocker les produits dans leur emballage d'origine dans un endroit propre, frais et sec.

Temperatura / Temperature / Temperature : **5÷30°C**

Umidità / Umidity / Umidité : **45÷75%**

Conservare i prodotti a temperatura ambiente (**20°C±5**) per **48 ore** prima dell'uso sulla macchina confezionatrice.

Store the products at room temperature (20°C±5) for 48H before using on packaging machine.

Stocker les produits à température ambiante (20°C±5) pendant 48 heures avant l'utilisation sur la machine d'emballage.