

Art. cod. 07C062.01

Descrizione / Description / Description

Contagocce 18/415 liscio LPS62

Dropper 18/415 glossy LPS62

Compte-gouttes 18/415 brillant LPS62



Tabella dati tecnici / Technical data table / Tableau données techniques



Pos. componente <i>Component pos.</i> <i>Pos. Du Composant</i>	Tipo filetto <i>Thread type</i> <i>Type filet</i>	Passo filetto (mm) <i>Thread pitch (mm)</i> <i>Pass de filet (mm)</i>	N° Principi filetto <i>N° Thread starts</i> <i>N° Pass de vis filet</i>	Sigillo di garanzia <i>Tamper evident</i> <i>Inviolabilité</i>	Materiale <i>Material</i> <i>Matière</i>	Peso (g) <i>Weight (g)</i> <i>Poids (g)</i>
1	18/415	-	-	No/No/Non		3,95 ±0,30
2	-	-	-	-		
3	-	-	-	-		

Il peso indicato è puramente indicativo e non valido ai fini CONAI.

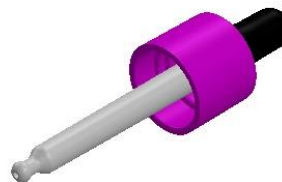
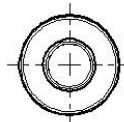
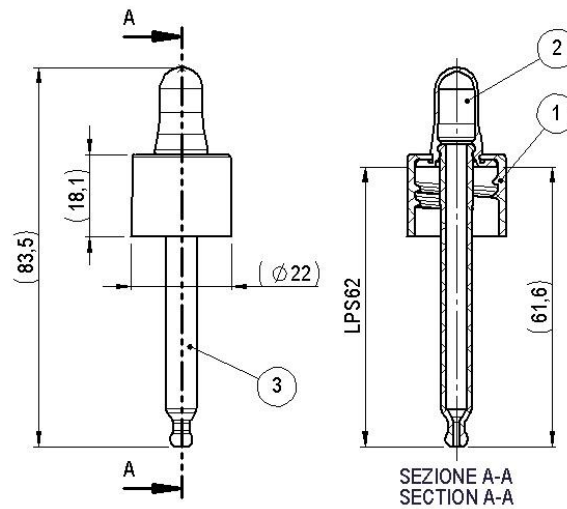
The weight indicated is purely indicative.

Le poids indiqué est indicatif.



PLASTIC CLOSURES

.....▶ www.capsol-spa.com

Tabella dati imballaggio-spedizione / Table packing and shipping details / Table données d'emballage-expédition

Scatola standard (cm)	Sacchetto	Quantità per scatola	Quantità per pallet	Pallet (cm)
<i>Standard box (cm)</i>	<i>Bag</i>	<i>Pcs box</i>	<i>Pcs pallet</i>	<i>Pallet (cm)</i>
<i>Carton standard (cm)</i>	<i>Sachet</i>	<i>Pcs carton</i>	<i>Pcs palette</i>	<i>Palette (cm)</i>
78x39 H:30	PE Food contact			120x80 H:190

Stoccaggio / Storage / Stockage

Conservare i prodotti nella loro confezione originale in un luogo pulito, fresco e asciutto.
Store the products in their original packaging in a clean, cool and dry place.
Stocker les produits dans leur emballage d'origine dans un endroit propre, frais et sec.

Temperatura / Temperature / Temperature : **5÷30°C**

Umidità / Humidity / Umidité : **45÷75%**

Conservare i prodotti a temperatura ambiente (**20°C±5**) per **48 ore** prima dell'uso sulla macchina confezionatrice.
Store the products at room temperature (20°C±5) for 48H before using on packaging machine.
Stocker les produits à température ambiante (20°C±5) pendant 48 heures avant l'utilisation sur la machine d'emballage.