

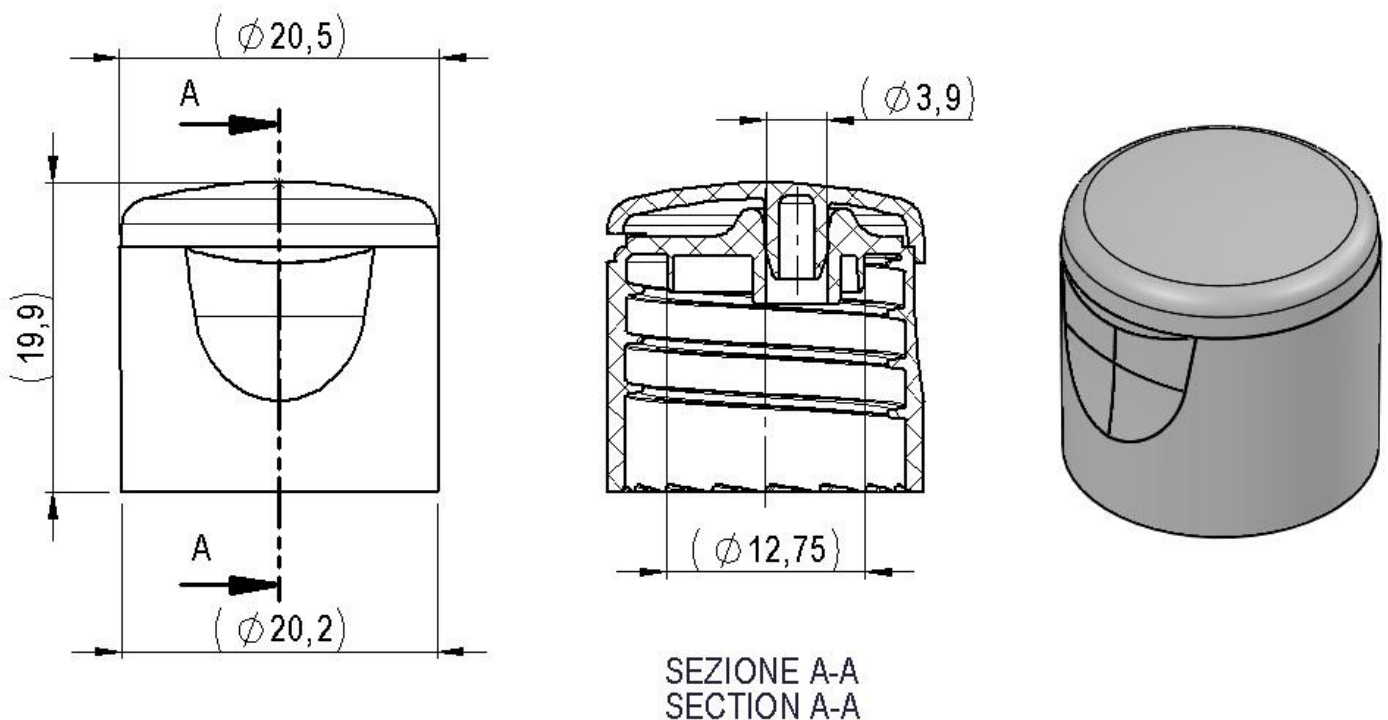







Art. cod. CE00484
Descrizione / Description
Capsula Flip-Top cilindrica 18/415
Cylindrical Flip-Top cap 18/415

Tabella dati tecnici / Technical data table

					
Tipo filetto Thread type	Passo filetto (mm) Thread pitch (mm)	N° Principi filetto N° Thread starts	Sigillo di garanzia Tamper evident	Materiale Material	Peso (g) Weight (g)
18/415	-	-	No/no		2,0 ±0,15

Il peso indicato è puramente indicativo e non valido ai fini CONAI.

The weight indicated is purely indicative.

Tabella dati imballaggio-spedizione / Table packing and shipping details

Scatola standard (cm) <i>Standard box (cm)</i>	Sacchetto <i>Bag</i>	Quantità per scatola <i>Pcs box</i>	Quantità per pallet <i>Pcs pallet</i>	Pallet (cm) <i>Pallet (cm)</i>
38x38 H:33	PE Food contact	5500	99000	120x80 H:110,5

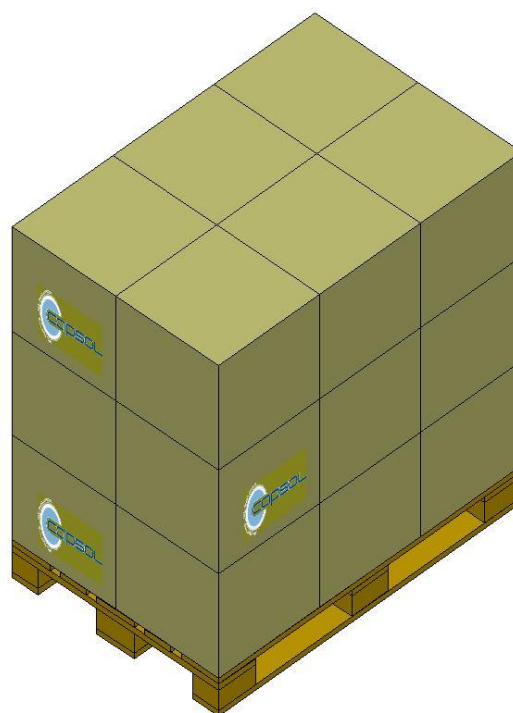

Stoccaggio / Storage

Conservare i prodotti nella loro confezione originale in un luogo pulito, fresco e asciutto.
Store the products in their original packaging in a clean, cool and dry place.

Temperatura / Temperature : **5÷30°C**

Umidità / Humidity : **45÷75%**

Conservare i prodotti a temperatura ambiente (**20°C±5**) per **48 ore** prima dell'uso sulla macchina confezionatrice.
*Store the products at room temperature (**20°C±5**) for **48H** before using on packaging machine.*